

Technical Data Sheet

Bristol 8762 Fuel Conversion from NG to LP



Kit 97-56621

KIT COMPONENTS:

7200-468 - #54 Rear Burner Orifice
7200-469 - #57 Front Burner Orifice
7211-136 - 0.35mm Pilot Orifice
7211-344 - Motorized LP Regulator
LP Sticker - (RED)
Instructions

TOOLS REQUIRED:

Phillips Screwdriver
T20 Torx or Flat-head Screwdriver
½" (13mm) Socket or Wrench
5/32" (4mm) Hex Wrench

-  **CAUTION: TURN OFF THE GAS SUPPLY, DISCONNECT ANY ELECTRICAL SOURCE TO YOUR STOVE, AND REMOVE THE BATTERIES FROM THE RECEIVER BEFORE MAKING THIS CONVERSION.**
-  **IMPORTANT: This kit and these instructions apply to the Bristol DX 8762 model only. DO NOT attempt this conversion on any other model.**

 **WARNING: THIS CONVERSION KIT MUST BE INSTALLED BY A QUALIFIED GAS SERVICE AGENCY IN ACCORDANCE WITH THE MANUFACTURER'S INSTRUCTIONS AND ALL APPLICABLE CODES AND REQUIREMENTS OF THE AUTHORITY HAVING JURISDICTION. IF THE INFORMATION IN THESE INSTRUCTIONS IS NOT FOLLOWED EXACTLY, A FIRE, EXPLOSION, OR PRODUCTION OF CARBON MONOXIDE MAY RESULT - CAUSING PROPERTY DAMAGE, PERSONAL INJURY, OR LOSS OF LIFE. THE QUALIFIED SERVICE AGENCY PERFORMING THIS WORK ASSUMES RESPONSIBILITY FOR THE PROPER CONVERSION OF THIS APPLIANCE WITH THIS KIT.**

 **ATTENTION: CET ÉQUIPEMENT DE CONVERSION SERA INTALLÉ PAR UNE AGENCE QUALIFIÉE DE SERVICE CONFORMÉMENT AUX INSTRUCTIONS DU FABRICANT ET TOUTES EXIGENCES ET CODES APPLICABLES DE L'AUTORISÉS AVOIR LA JURIDICTION. SI L'INFORMATION DANS CETTE INSTRUCTION N'EST PAS SUIVIE EXACTMENT, UN FEU, EXPLOSION OU PRODUCTION DE PROTOXYDE DE CARBONE PEUT RÉSSLER LE DOMMAGES CAUSER DE PROPRIÉTÉ, PERTE OU BLESSURE PERSONELLE DE VIE. L'AGENCE QUALIFIÉE DE SERVICE EST ESPONSABLE DE L'INSTALLATION PROPRE DE CET ÉQUIPEMENT. L'INSTALLATION N'EST PAS PROPRE ET COMPLÈTE JUSQU'À OPÉRATION DE L'APPAREIL CONVERTI EST CHÉQUE SUIVANT LES CRITÈRES ÉTABLIS DANS LES INSTRUCTIONS DE PROPRIÉTAIRE PROVISIONNÉES AVEC L'ÉQUIPEMENT.**

PROCEDURE:

1. Turn off the gas supply to the valve. Unplug the Fan Control Module from the 120 volt receptacle.
2. **Receiver Module Battery Removal:**
 - a. Move the Receiver's switch to the OFF position. Remove the cover plate screws and pry the entire plate with the switch off the receiver's battery compartment.
 - b. Remove the four batteries from the compartment
3. Remove the top and front façade. Remove the front glass assembly. To remove the glass assembly pull the spring mounted handles forward and up to free the glass frame. Carefully set everything aside. Remove the logs and set them aside. Carefully remove the ember burner. Refer to the owner's manual for additional instructions.
4. From underneath the stove loosen (but do not remove) the nuts that lock the air shutters in place. Adjust the air shutters to a preliminary fully opened position (for LP) by loosening the adjusting stud lock nuts underneath the stove. Moving the adjusting stud towards the valve opens the shutters, and away closes the air shutters. When the shutters are in the desired initial position tighten the locking nuts finger tight. See *Figure 1* below.

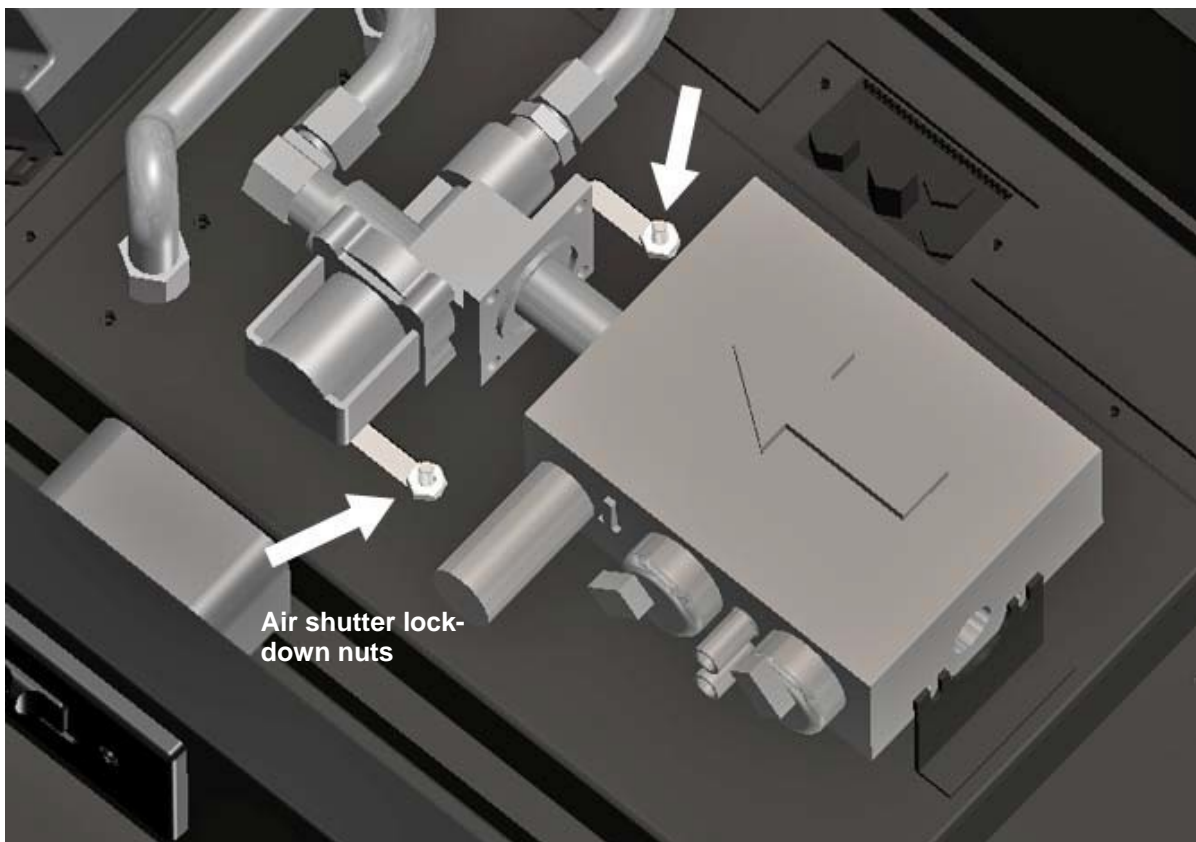

Figure 1

5. Find the two burner orifices. Using a 1/2" (13mm), socket or wrench remove the NG orifices. Locate the #57 LP orifice and install in the front location, and the #54 in the rear position. **NOTE:** Stoves installed above 2,000 feet (610m) may require de-rated orifices (see specs on page 5).

6. Locate the pilot assembly inside the center, rear of the firebox (see *Figure 2*). Remove the easy-off top of the pilot burner hood by grasping it and pulling it up, and off the pilot assembly.

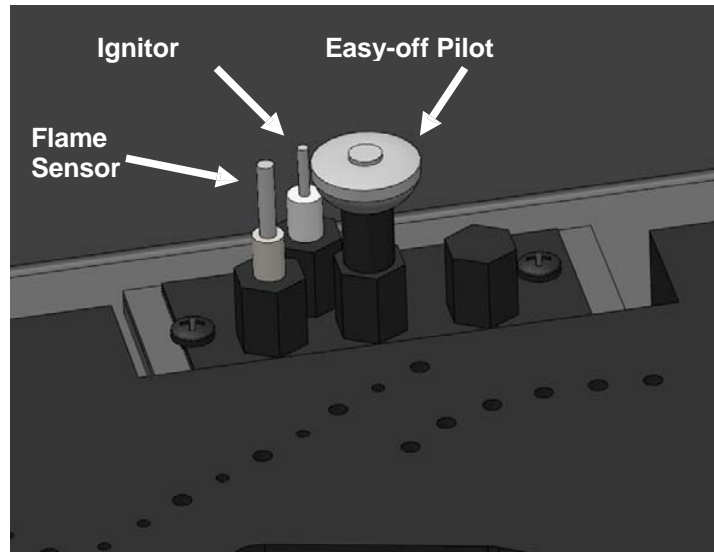
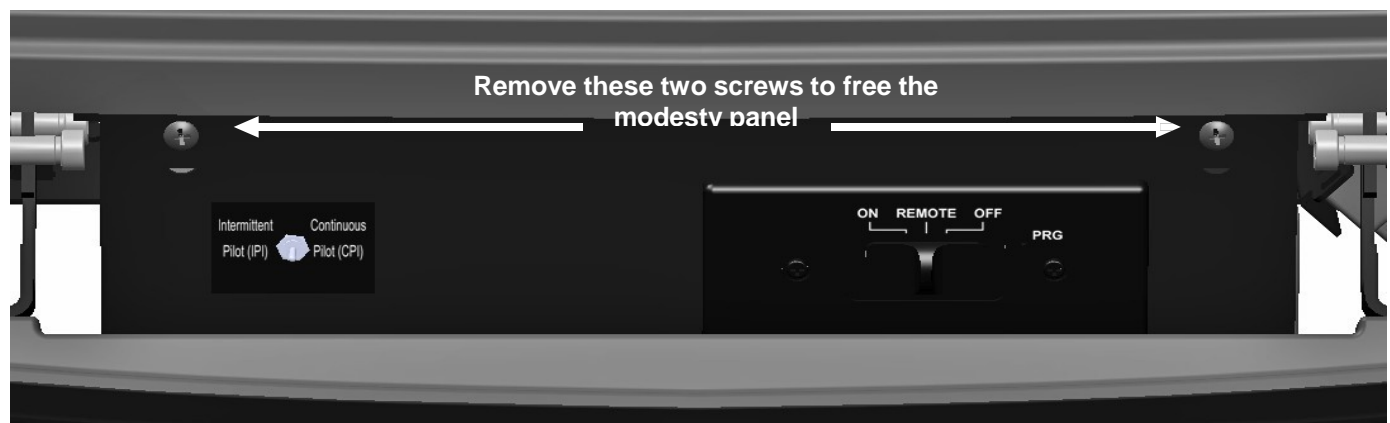

Figure 2

7. Using a 5/32" (4mm) hex wrench, unscrew and remove the NG pilot orifice. Insert the 0.35mm LP orifice provided with this kit and tighten it with the hex wrench.
8. Snap the pilot burner hood back into place on the pilot stem, ensuring the cutout of the hood aligns with tang on the orifice housing.
9. Reinstall the ember burner. Reinstall the logs according to the instructions in the owner's manual.
10. Replace and secure the front glass assembly and casting. Set the top back in place.

VALVE CONVERSION: See illustrations on following pages.

11. The Bristol 8762 model stove is equipped with a motorized valve regulator that permits flame height control via a hand held remote.
12. Remove the modesty panel by removing the two Phillips head screws on the face of the panel. Locate the valve inside the control door under the front of the stove.



13. Locate and remove the two screws that mount the motorized regulator to the valve.

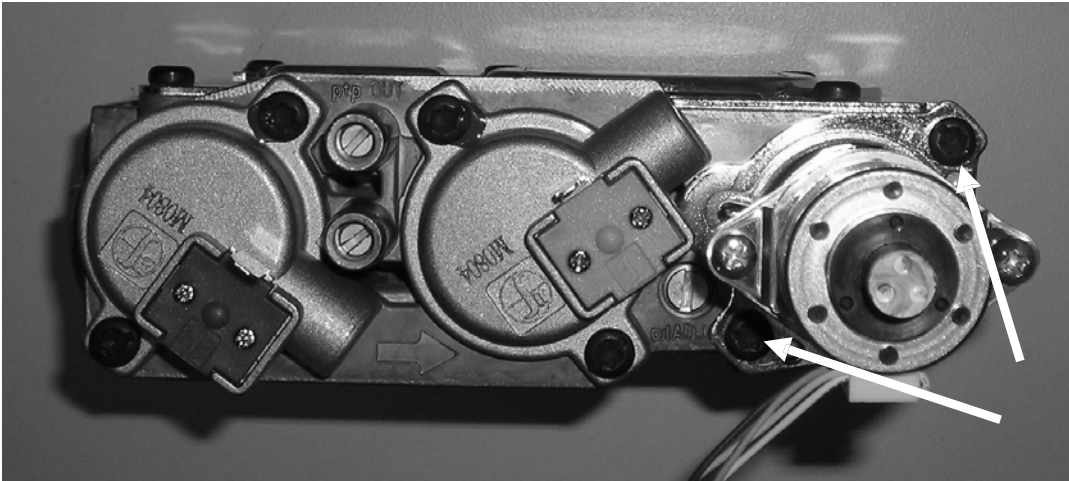

Figure 4

14. You will need to disconnect the motor lead. Follow the wires from the stepper motor back until the first connection. Disconnect the wires at this junction. See *Figure 5*.

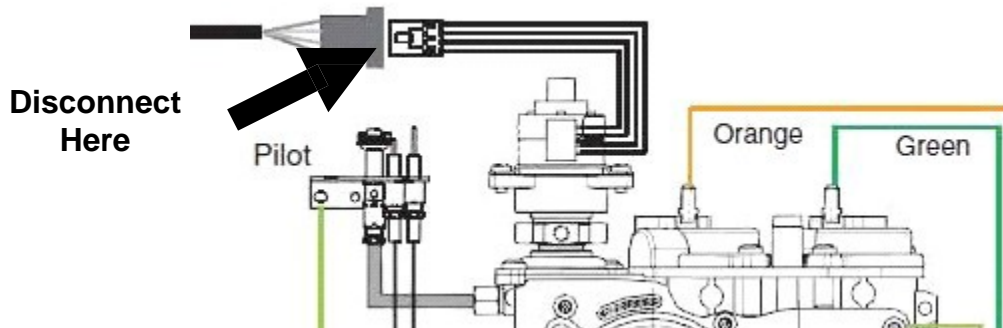

Figure 5 - Motor Lead Connection Detail

15. Pull the Motorized NG regulator off the stove. Ensure you remove the rubber gasket from the valve body before installing the Motorized LP regulator.
16. Place the Motorized LP regulator in position and replace the two screws to lock it in place. Reconnect the stepper motor wire lead.
17. Place the red LP sticker on the lighting instructions.

 **LEAK TEST ALL FITTINGS WITH A GAS SNIFFER BEFORE AND AFTER LIGHTING THE STOVE**

18. Once the leak tests are complete, replace the modesty panel and record this change by filling out the fuel conversion label on the stove.

19. Receiver Battery Installation

- Install four AA batteries. Ensure you orient the batteries correctly as indicated on the battery compartment cover.
- Ensure the switch is still in the OFF position, align the slider with switch stem and snap the cover plate back onto the battery compartment.
- Replace the cover plate screws.

20. Initializing the Remote Control

Note: Whenever you replace batteries, you must synchronize communication between the Receiver and the Remote Control transmitter.

- a. Place the slider switch in the REMOTE position.
 - b. Insert the end of a paper clip into the hole marked PRG on the Receiver cover. The Receiver will beep three times to indicate it is ready to synchronize with the Remote Control.
 - c. Push the Remote's ON button. The Receiver will beep four times to indicate the Remote's command is accepted and is set to the particular code of that Remote. The system is now initialized.
21. After the conversion is complete, and the logs are repositioned, seal the firebox and make final adjustments to the flame for each burner section.
- a. **Important: Burn the stove for at least 15 minutes before making any air shutter adjustments. Ensure that orange flames are not present, as this is a sign of incomplete combustion and will produce soot.**

The input rate of the heater is verified by checking the manifold pressure. If the manifold pressure is correct, then the input rate is correct.

Specification	NG	LP
INPUT RATING (Btu/hr) 0-610 m / 0-2000 ft	36,000	33,000
INPUT RATING (Btu/hr) 610-1370 m / 2000-4500 ft	35,000	30,000
MAXIMUM OUTPUT (Btu/hr) 0-610 m / 0-2000 ft	28,200	26,200
MINIMUM INPUT (btu/hr) 0-610 m / 0-2000 ft	16,000	10,000
ORIFICE SIZE (DMS) 0-610 m (f/r) / 0-2000 ft	43/46	54/57
ORIFICE SIZE (DMS) 610-1370 m (f/r) / 2000-4500 ft	43/47	55/59
MANIFOLD PRESSURE - (in. W.c./kpa)	3.5/0.87	10.0/2.48
MANIFOLD PRESSURE - Low setting (in. W.c./kpa)	1.1/.027	6.4/1.59
INLET PRESSURE - MINIMUM (in.w.c./kpa)	5.0/1.25	12.0/2.99
INLET PRESSURE – MAXIMUM (in. w.c./kpa)	7.0/1.74	13/3.22

Note: Refer to the owner's manual for the:

- a. Details on adjustment for the proper pilot and main burner flame appearance.
- b. Instructions for checking out the normal operating sequence of the ignition system.
- c. Location on the valve to check manifold pressure.

 **DO NOT REUSE THE PARTS THAT WERE REMOVED FROM THE STOVE!**